

Panasonic®

Operating Instructions

Multi-Format Compact Live Switcher

Model No. **AV-HS300**

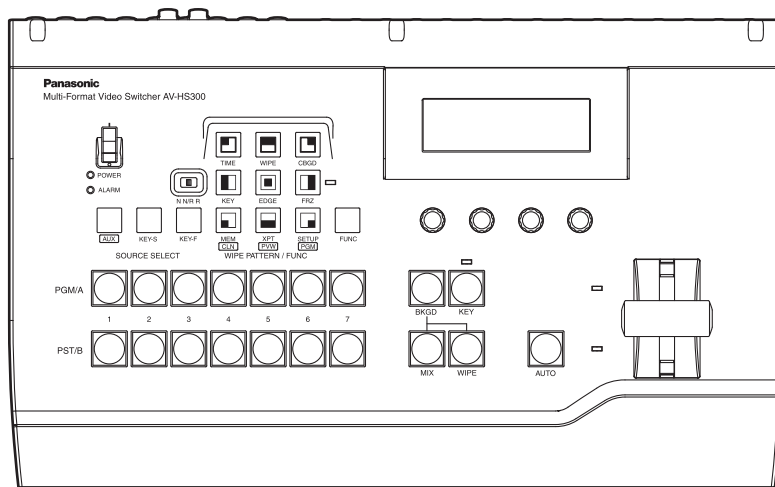

Before operating this product, please read the instructions carefully and save this manual for future use.

Safety precautions



CAUTION

**RISK OF ELECTRIC SHOCK
DO NOT OPEN**



CAUTION: TO REDUCE THE RISK OF ELECTRIC SHOCK,
DO NOT REMOVE COVER (OR BACK).
NO USER SERVICEABLE PARTS INSIDE.
REFER TO SERVICING TO QUALIFIED SERVICE PERSONNEL.



The lightning flash with arrowhead symbol, within an equilateral triangle, is intended to alert the user to the presence of uninsulated "dangerous voltage" within the product's enclosure that may be of sufficient magnitude to constitute a risk of electric shock to persons.



The exclamation point within an equilateral triangle is intended to alert the user to the presence of important operating and maintenance (service) instructions in the literature accompanying the appliance.

For CANADA

This class A digital apparatus complies with Canadian ICES-003.

Cet appareil numérique de la classe A est conforme à la norme NMB-003 du Canada.

WARNING:

- TO REDUCE THE RISK OF FIRE OR ELECTRIC SHOCK, DO NOT EXPOSE THIS APPARATUS TO RAIN OR MOISTURE.
- THE APPARATUS SHALL NOT BE EXPOSED TO DRIPPING OR SPLASHING AND THAT NO OBJECTS FILLED WITH LIQUIDS, SUCH AS VASES, SHALL BE PLACED ON THE APPARATUS.

WARNING:

TO PREVENT INJURY, THIS APPARATUS MUST BE SECURELY ATTACHED TO THE FLOOR/WALL IN ACCORDANCE WITH THE INSTALLATION INSTRUCTIONS.

CAUTION:

TO REDUCE THE RISK OF FIRE OR SHOCK HAZARD AND ANNOYING INTERFERENCE, USE THE RECOMMENDED ACCESSORIES ONLY.

FCC Note:

This equipment has been tested and found to comply with the limits for a class A digital device, pursuant to Part 15 of the FCC Rules. These limits are designed to provide reasonable protection against harmful interference when the equipment is operated in a commercial environment. This equipment generates, uses, and can radiate radio frequency energy, and if not installed and used in accordance with the instruction manual, may cause harmful interference to radio communications. Operation of this equipment in a residential area is likely to cause harmful interference in which case the user will be required to correct the interference at his own expense.

Warning:

To assure continued FCC emission limit compliance, the user must use only shielded interface cables when connecting to external units. Also, any unauthorized changes or modifications to this equipment could void the user's authority to operate it.

CAUTION:

In order to maintain adequate ventilation, do not install or place this unit in a bookcase, built-in cabinet or any other confined space. To prevent risk of electric shock or fire hazard due to overheating, ensure that curtains and any other materials do not obstruct the ventilation.

Note:

The rating plate (serial number plate) is on the bottom of the unit.

The socket outlet shall be installed near the equipment and easily accessible or the mains plug or an appliance coupler shall remain readily operable.

A warning that an apparatus with CLASS I construction shall be connected to a MAINS socket outlet with a protective earthing connection.

Safety precautions

IMPORTANT SAFETY INSTRUCTIONS

Read these operating instructions carefully before using the unit. Follow the safety instructions on the unit and the applicable safety instructions listed below. Keep these operating instructions handy for future reference.

- 1) Read these instructions.
- 2) Keep these instructions.
- 3) Heed all warnings.
- 4) Follow all instructions.
- 5) Do not use this apparatus near water.
- 6) Clean only with dry cloth.
- 7) Do not block any ventilation openings. Install in accordance with the manufacturer's instructions.
- 8) Do not install near any heat sources such as radiators, heat registers, stoves, or other apparatus (including amplifiers) that produce heat.
- 9) Do not defeat the safety purpose of the polarized or grounding-type plug. A polarized plug has two blades with one wider than the other. A grounding-type plug has two blades and a third grounding prong. The wide blade or the third prong are provided for your safety. If the provided plug does not fit into your outlet, consult an electrician for replacement of the obsolete outlet.
- 10) Protect the power cord from being walked on or pinched particularly at plugs, convenience receptacles, and the point where they exit from the apparatus.
- 11) Only use attachments/accessories specified by the manufacturer.
- 12) Use only with the cart, stand, tripod, bracket, or table specified by the manufacturer, or sold with the apparatus. When a cart is used, use caution when moving the cart/apparatus combination to avoid injury from tip-over. 
- 13) Unplug this apparatus during lightning storms or when unused for long periods of time.
- 14) Refer all servicing to qualified service personnel. Servicing is required when the apparatus has been damaged in any way, such as power-supply cord or plug is damaged, liquid has been spilled or objects have fallen into the apparatus, the apparatus has been exposed to rain or moisture, does not operate normally, or has been dropped.

Contents

Description	5	3. Setup	26
Features	5	3-1 Setting the input signals	26
1. Parts and their functions	6	3-1-1 Setting the input signals (IN 1 to 5)	26
1-1 Control panel	6	3-1-2 Setting the input signal frame synchronizer	26
1-2 Crosspoint area	7	3-1-3 Setting the DVI input signals	27
1-3 Wipe area	8	3-2 Setting the output signals	29
1-4 Transition area	9	3-2-1 Types of output signals	29
1-5 LCD menu area	10	3-2-2 Selecting the AUX signals	29
1-6 Rear panel connections area	11	3-3 Selecting the video format	30
2. Basic operations	12	3-4 Setting the crosspoints	31
2-1 Transitions	12	3-4-1 Assigning signals to the crosspoints	31
2-1-1 Selecting the bus	12	3-4-2 Setting the crosspoint switching	32
2-1-2 Selecting the bus mode	12	3-5 Setting the sync signals	33
2-1-3 Selecting the transition mode	13	3-6 Adjusting the output signal phase	34
2-1-4 Manual transition (using the fader lever)	13	3-7 Network settings	36
2-1-5 Auto transition	13	3-8 Other settings	38
2-2 Wipe	14	3-8-1 LCD backlight	38
2-2-1 Selecting the wipe pattern	14	3-8-2 Setting the ancillary data	38
2-2-2 Selecting the wipe direction	14	3-8-3 BB signal setup level	38
2-2-3 Wipe decorations (border, soft effect)	14	3-9 Status displays	39
2-3 Key	16	3-10 Initialization	39
2-3-1 Selecting the key source	16	4. Setting menu table	40
2-3-2 Setting the key	17	5. Image transmission functions	45
2-3-3 Key adjustments	17	6. External interfaces	49
2-3-4 Selecting key fill	18	6-1 RS-422 connector	49
2-3-5 Key decorations	19	6-2 GPI connector	49
2-4 Color background	21	6-3 Tally connector	49
2-5 Freezing the input signals	22	7. Connections	50
2-6 Frame memory	23	8. Appearance	52
2-7 Preset memory	24	Specifications and standard accessories	53
		Appendix (glossary)	55

Description

This unit is a single-ME digital video switcher which supports multiple HD and SD formats. While featuring compact dimensions, it can optionally support HD analog component inputs (×5) in addition to the five SDI inputs and one DVI-I input. Since a frame synchronizer is incorporated for each of the inputs, signals can be switched without “shocking” or “freezing” non-synchronized video signals. Furthermore, the images created by a PC can be imported via Ethernet.

Features

- **Six inputs, three outputs supported despite its compact size**

The standard configuration consists of six inputs (five SDI inputs and one DVI-I input) and three SDI outputs (PGM, PVW and AUX). Optionally, the unit is also capable of supporting HD analog component inputs (×5). The SDI inputs support active through outputs. Key inputs can be selected from the six video inputs for use.

- **Multiple formats supported**

HD formats (1080/59.94i, 1080/50i, 720/59.94p and 720/50p), SD formats (480/59.94i and 576/50i) and DVI-I (input only) are supported as the signal formats.

- **Frame synchronizer system and external sync system supported**

The unit contains a high-performance 10-bit frame synchronizer to enable non-synchronized images to be input. By using the BB signal output, a system can be configured using the switcher’s sync signals as a reference. Gen-lock is also possible with external sync signals (BB or TRI signals).

- **Built-in effects and key combination functions**

The unit provides nine different waveform patterns as wipe patterns to add borders or soft effects. Key combination supports self keys and linear keys, and key inversion is also possible.

- **Ethernet and control interfaces supported**

The unit can import images created on a PC into its frame memory over Ethernet (100 Mbps or 10 Mbps) and use them as background images or key input signals. External control using RS-422 or GPI signals is also supported. In addition, the unit comes with six tally outputs.

- **External power supply system**

The unit is powered by an external DC 12 V power supply so it can be used not only indoors but in the field as well. (However, the unit is not constructed to be rain-proof or drip-proof so keep it away from rain or moisture.)

- **Easy operability**

The simple panel layout which enables the functions to be operated directly enables speedy live transmissions. Preset-like operations can be performed on the LCD panel using a menu-driven format.

1. Parts and their functions

1-1. Control panel

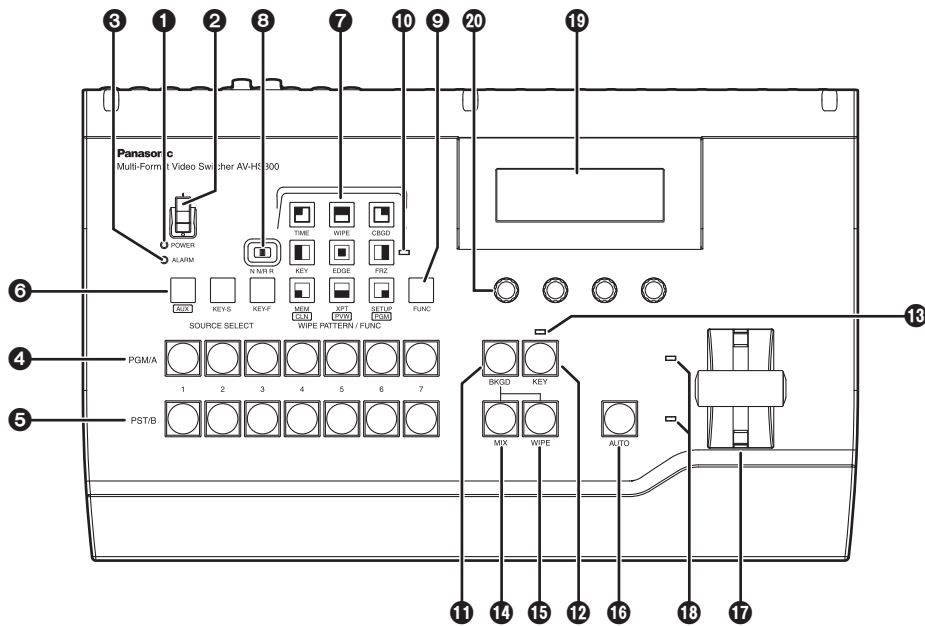

① Power indicator [POWER]

This lights when the power switch (②) is set to ON while power is supplied to the DC power socket. It goes off when the power switch (②) is set to OFF.

② Power switch

When this switch is set to "I" while power is supplied to the DC power socket, the unit's power is turned on, and the power indicator (①) lights. When it is set to "O", the unit's power is turned off, and the power indicator (①) goes off.

③ Alarm indicator [ALARM]

This lights when the fan has stopped running or when something is wrong with the DC power (such as a drop in voltage). Which type of trouble has occurred can be checked on the LCD's status menu. Contact your dealer if the indicator remains lighted.

1. Parts and their functions

1-2. Crosspoint area

④ PGM/A bus crosspoint switches [PGM/A 1 to 7]

These are used to select the PGM/A bus video signals. In the case of the flip-flop system, the main line video (PGM) signals are always selected.

⑤ PST/B bus crosspoint switches [PST/B 1 to 7]

These are used to select the PST/B bus video signals. In the case of the flip-flop system, the images inserted next (PST) are always selected. When a B bus crosspoint switch is pressed while one of the source selector switches (⑥) is held down, key signals or AUX signals are selected.

⑥ Source selector switches [SOURCE SELECT/AUX, KEY-S, KEY-F]

When a B bus crosspoint switch (⑤) is pressed while the [AUX] source selector switch is held down, the AUX signals are selected, and when a B bus crosspoint switch (⑤) is pressed while the [KEY-S] or [KEY-F] source selector switch is held down, the key signals are selected.

While a switch is held down, its indicator lights in amber.

In addition, if the [CLN], [PVW] or [PGM] wipe pattern selector switch (⑦) is pressed while the [AUX] switch is held down, the switch will operate as an AUX bus selector switch.

[CLN]: Clean signals are output to the AUX bus.  See 3-2-2

[PVW]: PVW signals are output to the AUX bus.  See 3-2-2

[PGM]: PGM signals are output to the AUX bus.  See 3-2-2

1. Parts and their functions

1-3. Wipe area

7 Wipe pattern selector switches [WIPE PATTERN / FUNC]

These are used to select the wipe patterns. Each switch is used to select one of the nine wipe patterns.

The indicator of the switch for the selected pattern lights (in amber).

When the [FUNC] switch (9) has been pressed and its indicator is lighted, the function setting menu is selected, and the indicator lights up green.

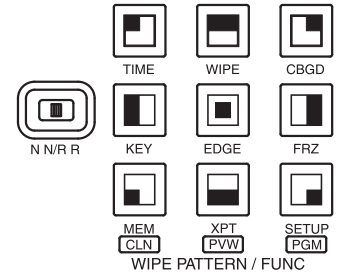

8 Wipe direction selector switch [N N/R R]

This is used to select the wipe direction. See 2-2-2

[N]: For setting the wipe direction to the normal direction.

[N/R]: To switch the wipe direction between normal and reverse when the execution of the transition has been completed.

[R]: For setting the wipe direction to the reverse direction.

9 [FUNC] switch

When this switch is pressed, its indicator lights up green. If a wipe pattern selector switch is pressed while its indicator is lighted, the wipe pattern selector switch lights up green, and the setting menu of the function indicated underneath the switch appears on the LCD display.

- [TIME]: For setting the auto transition time. See 2-1-5
- [WIPE]: For setting the wipe border and soft effect. See 2-2-3
- [CBGD]: For setting the color background. See 2-4
- [KEY]: For setting the key. See 2-3
- [EDGE]: For setting the key edge. See 2-3-5
- [FRZ]: For displaying the freeze status display and setting freezing. See 2-5
- [MEM]: For setting the preset memory or frame memory. See 2-6, 2-7
- [XPT]: For displaying and setting the crosspoint assignment. See 3-4
- [SETUP]: For performing the system settings. See 3

10 Freeze status indicator LED

When this LED is lighted, it means that one of the input signals is frozen.

When the [FUNC] switch (9) is pressed and its indicator is lighted and then the [FRZ] switch is pressed, the freeze status is indicated for each input. (An asterisk (*) appears above the name of a frozen crosspoint.)

Bear in mind that since the signals are frozen while the indicator is lighted, the unit's output will remain unchanged even if the input images change.

(When crosspoints 3 and 5 are frozen)

FRZ		FRZ:		*	*
1 / 2		XPT:	1	2	3 4 5 6 7

1. Parts and their functions

1-4. Transition area

① [BKGD] switch

This executes the background transition when the [AUTO] switch (⑩) or fader lever (⑰) has been operated.

When the [BKGD] switch is pressed and it is selected, its indicator is lighted in red. If the [KEY] switch (⑫) is now pressed, the indicator goes off, and the de-selected status is established.

However, when the [BKGD] switch and [KEY] switch (⑫) are pressed at the same time, both switches are set to the selected status.

The selection status cannot be changed while a transition is being executed or suspended.

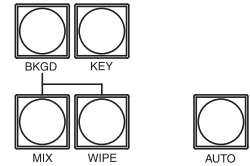

⑫ [KEY] switch

This executes the key transition (MIX) when the [AUTO] switch (⑩) or fader lever (⑰) has been operated. When the [KEY] switch is pressed and it is selected, its indicator is lighted.

When a transition is executed and the key ON status is established, the [KEY] switch lights in red. When another transition is executed and the key OFF status is established, it lights in amber.

If the [BKGD] switch (①) is now pressed, the indicator goes off, and the de-selected status is established. However, when the [BKGD] switch (①) and [KEY] switch are pressed at the same time, both switches are set to the selected status.

The selection status cannot be changed while a transition is being executed or suspended.

⑬ KEYON status indicator LED

This lights in red when the key ON status is established.

⑭ [MIX] switch

This is used to switch the A and B bus images while making them overlap.

During the transition, the A and B bus output total is kept at 100 %.

When the [MIX] switch is pressed and it is selected, its indicator lights in amber.

If the [WIPE] switch (⑮) is now pressed, it goes off, and the de-selected status is established.

⑮ [WIPE] switch

This is used to execute the transition using the pattern selected by the wipe pattern selector switch (⑦).

When the [WIPE] switch is pressed and it is selected, its indicator lights in amber.

If the [MIX] switch (⑭) is now pressed, it goes off, and the de-selected status is established.

⑯ [AUTO] switch

This is used to automatically execute transitions (auto transition) using the transition time which has been set. During auto transition its indicator lights in red. When the switch is pressed again during auto transition, the auto transition operation is suspended, and the indicator lights in green. When it is pressed again while auto transition is suspended, the remaining transition is executed.

The indicator goes off when auto transition is completed.

When the [AUTO] switch is pressed while the fader lever (⑰) is at an interim position, the remaining transition is executed using the transition time which has been set.

1. Parts and their functions

17 Fader lever

This is used to execute background or key transitions. When it is moved as far as it will go, the transition is completed. When it has been operated during auto transition, auto transition will be switched to manual operation as soon as the fader position overtakes the amount of the transition being executed.

18 Bus tally LEDs

These indicate the output statuses of the A bus and B bus. The LED corresponding to the bus whose program signals (PGM) are being output lights.

1-5. LCD menu area

19 LCD

The setting menus are displayed on the LCD.

When the [FUNC] switch (9) is pressed and its indicator is lighted and then one of the wipe pattern selector switches (7) is pressed, the setting menu for the function concerned is displayed.

20 Rotary encoders [F1] to [F4]

These are used to set the parameters displayed on the menu.

Menu items are selected and parameters set by rotating [F1] to [F4]. For details on their operation, refer to the items in "2. Basic operations".

When the [F1] to [F4] switches are held down, the parameters are returned to their default status. (Numerical value setting items only)

(Initial screen)

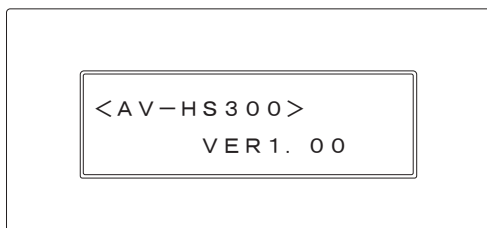

1. Parts and their functions

1-6. Rear panel connections area

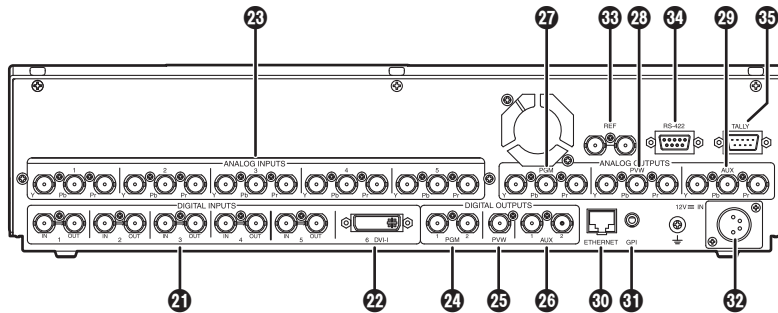

21 SDI signal input connectors [DIGITAL INPUTS 1 to 5]

IN: SDI signal input; OUT: active through output

22 DVI-I signal input connector [DIGITAL INPUTS 6 DVI-I]

23 Analog HD component input connectors [ANALOG INPUTS 1 to 5] (optional)

24 PGM output connectors [DIGITAL OUTPUTS PGM 1, 2] (SDI)

25 PVW output connector [DIGITAL OUTPUTS PVW 1] (SDI)

26 AUX output connectors [DIGITAL OUTPUTS AUX 1, 2] (SDI)

27 PGM output connector [ANALOG OUTPUTS PGM 1] (analog HD component)

28 PVW output connector [ANALOG OUTPUTS PVW 1] (analog HD component)

29 AUX output connector [ANALOG OUTPUTS AUX 1] (analog HD component)

30 Ethernet port [ETHERNET] (10BASE-T, 100BASE-TX)

31 GPI input connector [GPI] (auto take)

32 DC power socket

33 Reference input connector/BB output connector [REF]

Loop-through output in the external sync mode.

BB signals output from both connectors in the internal sync mode.

34 RS-422 interface connector [RS-422]

35 Tally output connector [TALLY]

2. Basic operations

2-1. Transitions

2-1-1. Selecting the bus

Press the crosspoint switches to select the material which will be targeted for the background transition. By pressing these switches, the signals are selected, and the indicators of the selected switches light. The color in which the switch indicators light differs depending on the operation status.

Lighting in red: When the selected input signals are output to PGM.

Lighting in green: When the selected input signals are not output to PGM.

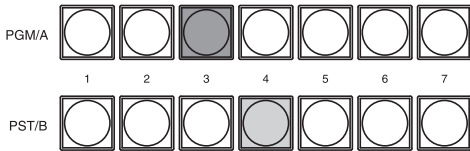

For details on how to select the key source bus and key fill bus, refer to “2-3-1” and “2-3-4”.
For details on how to select the AUX bus, refer to “3-2-2”.

2-1-2. Selecting the bus mode

Select the A/B bus system or flip-flop system (PGM/PST system) from the setting menu.

- ① Press the [FUNC] switch to light its indicator, and then press the [SETUP] switch to display the SETUP menu.
- ② Turn [F1] to display the BUS menu.
- ③ Turn [F2], and select the A/B or P/P (flip-flop system) using the MODE item.



With the flip-flop (P/P) system, the PGM/A bus selected signals are always output as PGM images, and the PST/B bus selected signals are always output as PVW (PST) images.

System	Video output	Before transition	During transition	After transition completion
A/B	PGM	PGM/A	PGM/A, PST/B	PST/B
	PVW (PST)	PST/B	PST/B	PGM/A

* With an A → B transition

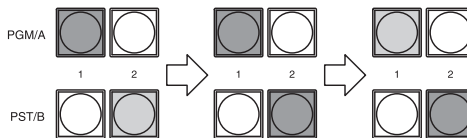

System	Video output	Before transition	During transition	After transition completion
Flip-flop P/P	PGM	PGM/A	PGM/A, PST/B	PGM/A
	PVW (PST)	PST/B	PST/B	PST/B

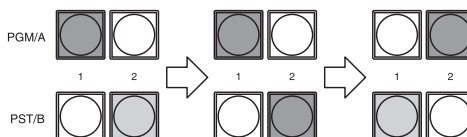

2. Basic operations

2-1-3. Selecting the transition mode

Use the [BKGD] and [KEY] switches in the transition area to select the bus signals for which the transition is to be executed. If the switches have been pressed at the same time, both switches are selected. The indicator of a selected switch lights.

The switches cannot be selected while a transition is being executed or suspended.

Use the [MIX] and [WIPE] switches in the transition area to select the background transition mode. Select one of these switches, and the indicator of the selected switch lights in amber.

MIX always applies to key transitions whichever switch has been selected.

2-1-4. Manual transition (using the fader lever)

Operate the fader lever to execute transitions manually.

If the fader lever has been operated during auto transition, auto transition will be switched to manual operation as soon as the fader position overtakes the amount of the transition being executed.

The bus tally LEDs on the left of the fader lever indicate the program bus output status.

Top LED only lights: PGM, A bus output

Top and bottom LEDs light: Transition underway

Bottom LED only lights: B bus output

2-1-5. Auto transition

- When the [AUTO] switch is pressed, the transition is executed automatically using the transition time which has been set.
- If the [AUTO] switch is pressed while the fader lever is at a midway position, the remaining transition will be executed automatically using the transition time which has been set.
- The auto transition time is set using the menu. It can be set separately for BKGD and KEY.
 - ① Press the [FUNC] switch to light its indicator, and press the [TIME] switch to display the TIME menu.
 - ② Turn [F1] to display the BKGD or KEY menu.
 - ③ Turn [F4] to select the display unit using the UNIT item.
 - ④ When frames (F) have been selected as the unit, turn [F3] to set the transition time.
 - ⑤ When seconds (SEC) have been selected as the unit, turn [F2] to set the second units or [F3] to set the frame units.

(With BKGD and seconds (SEC) as the display unit)

BKGD		TIME		UNIT
1/2		16s		SEC

(With KEY and frames (F) as the display unit)

KEY		TIME		UNIT
2/2		999f		F

- Any time from 0 to 999f can be set. The time which can be set when seconds are used as the display unit differs depending on the video format.
 - 59i:** max. 33s09f, **59p:** max. 16s18f
 - 50i:** max. 39s24f, **50p:** max. 19s49f

2. Basic operations

2-2. Wipe

2-2-1. Selecting the wipe pattern

Press one of the wipe pattern selector switches to select the desired wipe pattern from among the nine patterns available. The indicator of the selected wipe pattern selector switch lights in amber.

2-2-2. Selecting the wipe direction

Operate the transition direction selector switch (DIP switch) to select the wipe direction.



N: For setting the wipe direction to the normal direction.

N/R: To switch the wipe direction between normal and reverse when the execution of the transition has been completed.

R: For setting the wipe direction to the reverse direction.

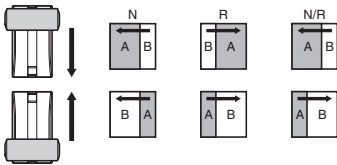

2-2-3. Wipe decorations (border, soft effect)

■ Adding borders

Borders can be added to the wipe edges.

- ① Press the [FUNC] switch to light its indicator, and then press the [WIPE] switch to display the WIPE menu. The BODR menu appears first.
- ② Turn [F2], and set the width of the border using the WIDT item. A setting of "0" means that the border is OFF.

BODR	WIDT	SOFT	COLR
1 / 5	0	0	WHT
0 - 2 5 5	0 - 2 5 5	Y LW	
		C YN	
		GRN	
		MGT	
		RED	
		BLE	
		BLK	
		USR 1	
		USR 2	
		USR 3	
		USR 4	

2. Basic operations

■ Changing the soft effect amount

On the BODR menu, turn [F3], and set the soft effect amount using the SOFT item.
A setting of "0" means that the soft effect is OFF.

■ Setting the border color

On the BODR menu, turn [F4], and set the border color using the COLR item.
When USR1 to 4 (user colors) has been selected, the color can be adjusted on the USR1 to 4 menu.

■ Adjusting the border color

When USR1, 2, 3 or 4 has been selected, the border color can be adjusted.
Use of USR1 to 4 is shared by the background color, fill color and edge color.

- ① Press the [FUNC] switch to light its indicator, and then press the [WIPE] switch to display the WIPE menu.
- ② Turn [F1] to display the USR1 to 4 (user color) menu.
- ③ Turn [F2], [F3] or [F4] to adjust the color (HUE, SAT or LUM).

USR1	HUE	SAT	LUM
2 / 5	100	100	100

0-359	0-100	0-108
-------	-------	-------

Operation	Parameter	Description of setting	Setting range (TBD)
F2	HUE	Hue	0 to 359
F3	SAT	Saturation	0 to 100
F4	LUM	Luminance	0 to 108

2. Basic operations

2-3. Key

2-3-1. Selecting the key source

■Selecting the key source signals

The signals assigned to crosspoints 1 to 7 can be used for the key source signals.

While holding down the [KEY-S] switch in the source selection area, press one of the B bus crosspoint switches [1] to [7] to select the key source signal. The indicators of the [KEY-S] switch and selected crosspoint switch light in amber.

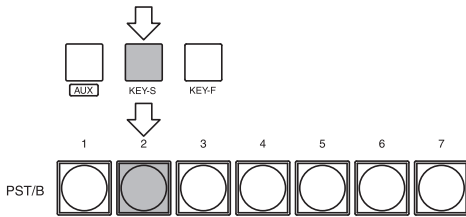

Provide materials with white key-combined characters or patterns on a black background as the key source signals. The keys may not be combined satisfactorily if the material has colors other than black and white. Material with black characters on a white background, for example, can be reversed for use using the key inversion function.

<How key combination works>

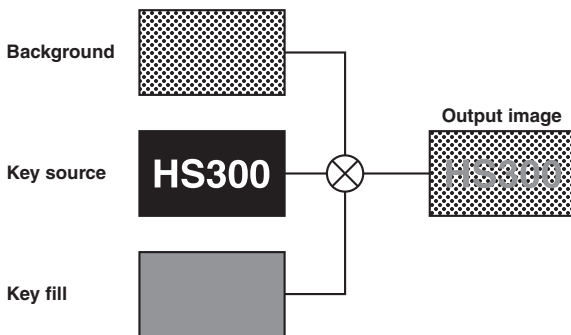

2. Basic operations

2-3-2. Setting the key

■Selecting the key type

- ① Press the [FUNC] switch to light its indicator, and then press the [KEY] switch to display the KEY menu.
- ② Turn [F1] to display the KEY menu (sub menu).
- ③ Turn [F2], and select the TYPE item.

SELF (self key/luminance key): The key signals are created from the luminance signals of the key fill material. Since key fill signals are used as the key source, the signals selected by the key source are ignored.

LIN (linear key/EXT key): The key signals are created from the luminance signals of the key source.

TYPE	KEY FILL	KEY SOURCE
SELF (self key/luminance key)	XPT1 to 7, FILL COLOR	Same as KEY FILL
LIN (linear key/EXT key)	XPT1 to 7, FILL COLOR	XPT1 to 7

KEY 1 / 7	TYPE SELF	INV ON	PVW ON
	LIN	OFF	OFF AUTO

■Setting key inversion

On the KEY menu, turn [F3] and set the INV item. Key inversion can now be set to ON or OFF.

■Selecting key preview

Select whether to display the key preview for the PVW output.

On the KEY menu, turn [F4] and set the PVW item.

ON: Images with key effects added are output to PVW.

OFF: Images with no key effects added are output to PVW.

AUTO: Preview images of the next transition are output to PVW.

2-3-3. Key adjustments

Adjust the key definition.

- ① Press the [FUNC] switch to light its indicator, and then press the [KEY] switch to display the KEY menu.
- ② Turn [F1] to display the K-ADJ menu.
- ③ Turn [F2], [F3] and [F4] to adjust the key definition.

K-ADJ 2 / 7	CLIP 50	GAIN 100	DENS 100
0-108	0-200	0-100	

Operation	Parameter	Description of setting	Setting range
F2	CLIP	Reference level for creating key signals	0 to 108 (TBD)
F3	GAIN	Key gain	0 to 200 (TBD)
F4	DENS	Key density	0 to 100 (TBD)

2. Basic operations

2-3-4. Selecting key fill

■Selecting the key fill signals

In addition to the signals assigned to crosspoints 1 to 7, special fill colors can be used for the key fill signals. While holding down the [KEY-F] switch in the source selection area, press one of the B bus crosspoint switches 1 to 7 to select the key fill signal. The indicators of the [KEY-F] switch and selected crosspoint switch light (in amber). Bus images are not used when the fill color has been selected on the menu.

When the [KEY-F] switch in the source selection area is pressed, the menu display is switched to the FILL menu, and the fill color can now be selected.

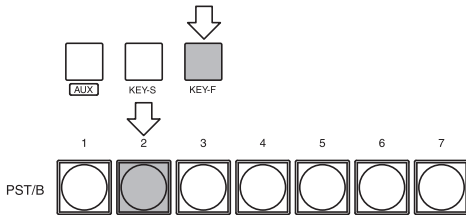

■Selecting the fill color

The fill color is selected on the menu.

- ① Press the [FUNC] switch to light its indicator, and then press the [KEY] switch to display the KEY menu.
- ② Turn [F1] to display the FILL menu.
- ③ Turn [F2], and select COLR (special fill color) from the TYPE item.
- ④ Turn [F3], and select the fill color from the COLR item.

FILL	TYPE	COLR	
3/7	BUS	WHT	

COLR	Y LW
	C YN
	G RN
	M GT
	R ED
	B LE
	B LK
	U SR 1
	U SR 2
	U SR 3
	U SR 4

2. Basic operations

■ Adjusting the fill color

The fill color can be adjusted when USR1 to 4 have been selected. Use of USR1 to 4 is shared by the border color, background color and edge color.

- ① Press the [FUNC] switch to light its indicator, and then press the [KEY] switch to display the KEY menu.
- ② Turn [F1] to display the USR1 to 4 (user color) menu.
- ③ Turn [F2], [F3] and [F4] to adjust the color (HUE, SAT and LUM).

USR 1	HUE	SAT	LUM
4 / 7	100	100	100

0-359	0-100	0-108
-------	-------	-------

2-3-5. Key decorations





■ Setting the key edge

A border, shadow or other edge can be added to the key.

- ① Press the [FUNC] switch to light its indicator, and then press the [EDGE] switch to display the EDGE menu. The EDGE setting screen appears first.

EDGE	TYPE	WIDT	COLR
1 / 5	BODR	4	WHT

DROP	0-8	Y LW
SHDW		CYN
OUTL		GRN
OFF		MGT
		RED
		BLE
		BLK
		USR 1
		USR 2
		USR 3
		USR 4

BORDER

DROP

SHADOW

OUTLINE

- ② Turn [F2] to select the edge type.
 - OFF:** An edge is not added.
 - BODR (BORDER):** A border is added around the entire edge.
 - DROP:** A diagonal border is added but only in the direction toward the bottom right of the key.
 - SHDW (SHADOW):** A shadow is added but only in the direction toward the bottom right of the key.
 - OUTL (OUTLINE):** An outline (only a border with no fill) is added.
- ③ Turn [F3] to set the edge width.
- ④ Turn [F4] to select the edge color.

2. Basic operations

■ Adjusting the edge color

The edge color can be adjusted when USR1, 2, 3 or 4 has been selected. Use of USR1 to 4 is shared by the border color, background color and fill color.

- ① Press the [FUNC] switch to light its indicator, and then press the [EDGE] switch to display the EDGE menu.
- ② Turn [F1] to display the USR1 to 4 (user color) menu.
- ③ Turn [F2], [F3] and [F4] to adjust the color (HUE, SAT and LUM).

USR1	HUE	SAT	LUM
2 / 5	100	100	100

0-359

0-100

0-108

2. Basic operations

2-4. Color background

The color background to be used by the bus can be set.

One color among the eight preset colors (WHITE, YELLOW, CYAN, GREEN, MAGENTA, RED, BLUE and BLACK) and four user colors can be selected. HUE, SAT and LUM adjustments can be performed for the user colors.

- ① Press the [FUNC] switch to light its indicator, and then press the [CBGD] switch to display the CBGD menu.
- ② Turn [F2], and select the color using the COLR item.

CBGD	COLR		
1 / 5	WHT		

Y L W
C Y N
G R N
M G T
R E D
B L E
B L K
U S R 1
U S R 2
U S R 3
U S R 4

■ Adjusting the color background

The background color can be adjusted when USR1, 2, 3 or 4 has been selected. Use of USR1 to 4 is shared by the border color, background color and fill color.

- ① On the [CBGD] menu, turn [F1] to display the USR1 to 4 (user color) menu.
- ② Turn [F2], [F3] and [F4] to adjust the color (HUE, SAT and LUM).

USR 1	HUE	SAT	LUM
2 / 5	1 0 0	1 0 0	1 0 0

0-359	0-100	0-108
-------	-------	-------

2. Basic operations

2-5. Freezing the input signals

The input signals can be frozen and used. If any of the input signals has been frozen, the freeze status display LED lights. While signals are frozen, the tally signals of the corresponding input will not be output.

- ① Press the [FUNC] switch to light its indicator, and then press the [FRZ] switch to display the FRZ menu.
- ② Turn [F1] to display the FRZ (2/2) menu.
- ③ Turn [F2], and select the input video signals using the SIG item.
- ④ Press the [F4] switch to freeze or de-freeze the input image. If it is pressed when the display shows "ON", the input image is frozen, and it is de-frozen when the display shows "OFF".

FRZ	SIG		FRZ
2/2	IN1		ON

IN2
IN3
IN4
IN5
DVI

When the unit is used with the frame synchronizer function OFF, the output images may be disturbed when freezing is executed, but the frozen images will not be adversely affected.

2. Basic operations

2-6. Frame memory

AUX output signals can be stored in the frame memory for use. Stored images can be used as the bus images by assigning the FMEM signals using the crosspoint assignment process.

Images stored in the frame memory are also saved in the unit's flash memory so they can be used even after the power is turned off. Stored images have an 8-bit format so their image quality may appear downgraded.

- ① Press the [FUNC] switch to light its indicator, and then press the [MEM] switch to display the MEM menu.
- ② Turn [F1] to display the MEM menu.
- ③ Press the [F4] switch (EXEC) to store the still images in the frame memory.

FMEM	SIG	MEM	STOR
3/3	AUX	FMEM	EXEC

Images can also be imported into the frame memory from a PC via Ethernet. For details on how to transmit them, refer to "5. Image transmission functions".

2. Basic operations

2-7. Preset memory

Up to 10 panel settings can be stored in this memory (flash memory).
The table below lists the settings which are stored.

<Table of stored preset memory>

Item	Description of setting	Initial value (factory default)
Crosspoint	A bus	1
	B bus	2
	KEY-S	4
	KEY-F	5
	AUX bus	1
	Color background	WHITE
Wipe	Wipe pattern	4 (center)
	Border width	4 (TBD)
	Soft effect width	4 (TBD)
	Border color	YLW
Transition area	BKGD/KEY selection	BKGD
	MIX/WIPE selection	MIX
	Auto transition time (BKGD)	60F
	Auto transition time (KEY)	60F
Key	Key type (TYPE)	LIN
	Key adjustment (ADJ)	GAIN: 100 (TBD) CLIP: 50 (TBD) DENS: 100 (TBD)
	Inversion ON/OFF	OFF
	Fill color	GRN (TBD)
	Edge color	YLW (TBD)
	Edge ON/OFF (TYPE)	OFF
	Edge width	4 (TBD)
User color	User color 1 (HUE, SAT, LUM)	0, 0, 100 (TBD)
	User color 2 (HUE, SAT, LUM)	355, 100, 7 (TBD)
	User color 3 (HUE, SAT, LUM)	50, 100, 29 (TBD)
	User color 4 (HUE, SAT, LUM)	0, 0, 0 (TBD)

STORE: This is used to store the panel settings in the preset memory.

- ① Press the [FUNC] switch to light its indicator, and then press the [MEM] switch to display the MEM menu.
The PSMEM (1/3) menu appears first.
- ② Turn [F2], select "STOR" using the MODE item, turn [F3], and set the preset memory number using the NO. item.
- ③ Press the [F4] switch (EXEC) to store the settings.

P S M E M		M O D E		N O .		
1 / 3		S T O R		* 1 0		E X E C

R E C L C L R		1 - 1 0
------------------	--	---------

An asterisk (*) appears at the left of the number when data has been saved in the preset memory.

2. Basic operations

RECALL: This is used to recall the preset memory data and change the panel settings.

- ① Press the [FUNC] switch to light its indicator, and then press the [MEM] switch to display the PSMEM (1/3) menu.
- ② Turn [F2], select “RECL” using the MODE item, turn [F3], and set the preset memory number using the NO. item.
- ③ Press the [F4] switch (EXEC) to recall the settings.

Recall settings can be selected for the crosspoint settings.

ENBL: The data stored in the preset memory is used.

DSBL: The data stored in the preset memory is not used, and the settings prior to recall are retained.

- ① Press the [FUNC] switch to light its indicator, and then press the [MEM] switch to display the PSMEM (1/3) menu.
- ② Turn [F1] to display the PSMEM (2/3) menu.
- ③ Turn [F2], and select crosspoint disable (DSBL) or enable (ENBL) using the XPT item.

P S M E M		X P T		
2 / 3		D S B L		

E N B L

CLEAR: This is used to clear the preset memory content.

- ① Press the [FUNC] switch to light its indicator, and then press the [MEM] switch to display the PSMEM (1/3) menu.
- ② Turn [F2], select “CLR” using the MODE item, turn [F3], and set the preset memory number using the NO. item.
- ③ Press the [F4] switch (EXEC) to clear the content.

3. Setup

3-1. Setting the input signals

3-1-1. Setting the input signals (IN 1 to 5)

If HD has been selected as the system format, SDI or analog HD component can be selected for each input. This selection is possible only when the analog HD input option has been connected.

- ① Press the [FUNC] switch to light its indicator, and then press the [SETUP] switch to display the SETUP menu.
- ② Turn [F1] to display the IN1 to 5 menu.
- ③ Turn [F2], select the input signals using the SIG item, turn [F3], and select SDI or ANLG (analog HD component) using the MODE item.

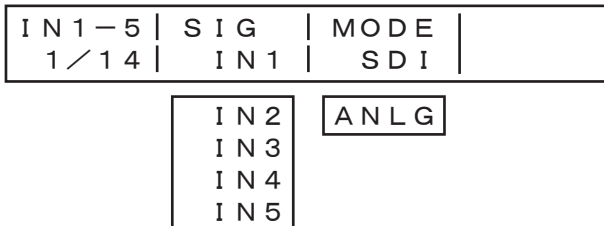

3-1-2. Setting the input signal frame synchronizer

The frame synchronizer can be set to ON or OFF for each input.

- ① Press the [FUNC] switch to light its indicator, and then press the [SETUP] switch to display the SETUP menu.
- ② Turn [F1] to display the FS menu.
- ③ Turn [F2], select the input signals using the SIG item, turn [F3], and select ON or OFF for the frame synchronizer using the FS item.

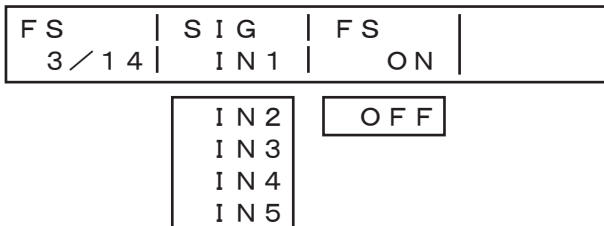

AVDL function is active while the frame synchronizer function is set to OFF.

The AVDL function automatically adjusts the input image signal phase to the horizontal synchronization reference signal phase.

For details, refer to "3-6. Adjusting the output signal phase".

3. Setup

3-1-3. Setting the DVI input signals

■Selecting the size

XGA or SXGA can be input as the size. The frequency is fixed at 60 Hz.

- ① Press the [FUNC] switch to light its indicator, and then press the [SETUP] switch to display the SETUP menu.
- ② Turn [F1] to display the DVIIN menu.
- ③ Turn [F2], and select the input size using the SIG item.

DVI IN	SIG	SCAL	MODE
2 / 14	SXGA	NORM	DIG

XGA	FULL	ANLG
-----	------	------

■Selecting the scaling method

NORM (normal): The size of the input images is increased or reduced while keeping their aspect ratio the same.

FULL (full): The size of the input images is increased or reduced in accordance with the system resolution. (The aspect ratio of the input images is not kept the same. The rate at which the image size is increased or reduced in the vertical direction and in the horizontal direction differs.)

For sizes for each format, refer to the following page <DVI input scaling size table>.

On the DVIIN menu, turn [F3], and select the scaling method using the SCAL item.

3. Setup

■Selecting the signal system









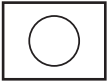
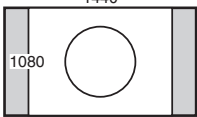

Select the digital or analog system for the DVI input video signals.

DIG (digital): Digital input signals of the DVI connector take effect.

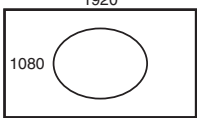
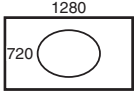
ANLG (analog): Analog input signals of the DVI connector take effect.

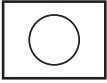
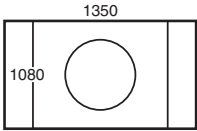
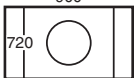
On the DVIIN menu, turn [F4], and select the signal system using the MODE item.

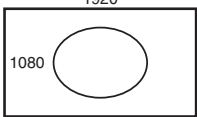
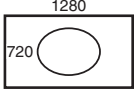
<DVI input scaling size table>

DVI format	Mode	HD/1080i	HD/720P	SD/NTSC	SD/PAL
		1920×1080	1280×720	720×480	720×576
XGA 1024×768 	NORM				
	FULL				
SXGA 1280×1024 	NORM				
	FULL				

3. Setup

3-2. Setting the output signals

3-2-1. Types of output signals

There are three output signal systems: PGM, PVW and AUX.

PGM: This is the main-line output of the switcher; images with wipe, mix, key and other effects added to them are output.

PVW: This is the preview output which enables the next operation to be checked in advance.

AUX: Signals selected by the AUX bus are output.

3-2-2. Selecting the AUX signals

One of the crosspoints 1 to 7, PGM, PVW or CLN signals can be selected for the AUX bus.

To select a crosspoint signal, press one of the B crosspoint switches 1 to 7 while holding down the [AUX] switch. The indicator of the selected switch lights (in amber), and the images are switched.

To select PGM, PVW or CLN signals, press one of the wipe pattern selector switches while holding down the [AUX] switch. The indicator of the selected switch lights (in amber), and the images are switched.

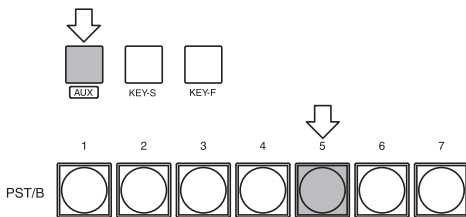

When CLN signals have been selected, images with the key signals removed from the PGM signals are output.

3. Setup

3-3. Selecting the video format

One system (input/output signal) video format can be selected. More than one format cannot be selected. If HD is selected, SDI or HD analog component can be selected for each input. (See 3-1-1)

- ① Press the [FUNC] switch to light its indicator, and then press the [SETUP] switch to display the SETUP menu.
- ② Turn [F1] to display the FORMT menu.
- ③ Turn [F2], select the format using the MODE item, and press the [F4] switch (EXEC) to enter the selection. An asterisk (*) appears at the left of the format currently selected.

FORMT	MODE	
4 / 1 4	* 1 0 8 0 / 5 9 i	EXEC

1 0 8 0 / 5 0 i
7 2 0 / 5 9 p
7 2 0 / 5 0 p
4 8 0 / 5 9 i
5 7 6 / 5 0 i

Display	HD/SD	Signal format	Input signals
1080/59i	HD	1080/59.94i	SDI / analog HD component
1080/50i	HD	1080/50i	SDI / analog HD component
720/59p	HD	720/59.94p	SDI / analog HD component
720/50p	HD	720/50p	SDI / analog HD component
480/59i	SD	480/59.94i	SDI
576/50i	SD	576/50i	SDI

3. Setup

3-4. Setting the crosspoints

3-4-1. Assigning signals to the crosspoints

External video input signals and internally generated signals can be assigned to crosspoint switches 1 to 7.

■Displaying the assignment statuses

- ① Press the [FUNC] switch to light its indicator, and then press the [XPT] switch to display the XPT menu.
- ② The XPTAS (1/3) menu appears first, and the assignment statuses are displayed. The names of the assigned signals are abbreviated on the display.

X P T A S	S I G :	B 1 2 3 4 5 D
1 / 3	X P T :	1 2 3 4 5 6 7

When one of the crosspoint switches 1 to 7 is held down for a long time, the name of the signal assigned is displayed on the LCD while the button is held down.

Example: When crosspoint switch 1 is pressed (when the black signal has been assigned to this switch).

X P T A S	S I G :	B L K
	X P T :	1

■Assigning signals to the crosspoints

- ① Press the [FUNC] switch to light its indicator, and then press the [XPT] switch to display the XPT menu.
- ② Turn [F1] to display the XPTAS (2/3) menu.
- ③ Turn [F2], select the crosspoint switch using the XPT item, turn [F2] and select the input signal using the SIG item.

X P T A S	X P T	S I G	
2 / 3	1	I N 1	

2	I N 2
3	I N 3
4	I N 4
5	I N 5
6	D V I
7	B L K
	C B G D
	C B A R
	F M E M

The table below lists the materials which can be assigned.

Switch	Signal	Abbreviation		Description
XP1 to 7	INPUT1 to 5	IN1 to 5	1 to 5	SDI or analog HD component
	DVIIN	DVI	D	DVI-I input
	BLACK	BLK	B	Internally generated signal, black
	COLOR BACKGROUND	CBGD	G	Internally generated signal, color background (matte)
	COLOR BAR	CBAR	C	Internally generated signal, color bar
	FRAME MEMORY	FMEM	F	Frame memory image

3. Setup

The table below lists the default settings.

Switch	Signal	Description
XP1	BLACK	Internally generated signal, black
XP2	INPUT1	External video input 1: SDI or analog HD component
XP3	INPUT2	External video input 2: SDI or analog HD component
XP4	INPUT3	External video input 3: SDI or analog HD component
XP5	INPUT4	External video input 4: SDI or analog HD component
XP6	INPUT5	External video input 5: SDI or analog HD component
XP7	DVIIN	External video input 6: DVI-I input

3-4-2. Setting the crosspoint switching

The timing at which the crosspoints are to be switched can be set.

ANY: The crosspoints are switched in the nearest field. This is suited to live applications.

F1: The crosspoints are switched in field 1. This is suited to editing applications.

F2: The crosspoints are switched in field 2. This is suited to editing applications.

- ① Press the [FUNC] switch to light its indicator, and then press the [XPT] switch to display the XPT menu.
- ② Turn [F1] to display the XPTSW menu.
- ③ Turn [F2], and select the switching timing using the TIMG item.



3. Setup

3-5. Setting the sync signals

The sync signals to be used by the system can be selected.

External sync: For synchronization with an external sync signal (gen-lock). The reference input signal is looped through and output.

BBST: Black burst signal (vertical phase of 0H)

BBAD: Black burst signal
(Vertical phase of 90H when the 59.94i or 59.94p format is selected;
vertical phase of 75H when the 50i or 50p format is selected)

TRI: Tri-level sync signal (vertical phase of 0H)
This can be selected when HD format signals are supplied.

Internal sync: For synchronization with an internal reference signal (INT). The REFOUT signal (black burst signal) is output from the two reference connectors. Its phase can be adjusted using a menu.

- ① Press the [FUNC] switch to light its indicator, and then press the [SETUP] switch to display the SETUP menu.
- ② Turn [F1] to display the REF menu.
- ③ Turn [F2], select the sync signal using the SYNC item, and press the [F3] switch (EXEC) to enter the selection.
An asterisk (*) appears at the left of the reference signal currently selected.

REF	SYNC		
5 / 1 4	* BBST		EXEC

BBAD
TRI
INT

3. Setup

3-6. Adjusting the output signal phase

The phase of the output video signals can be adjusted.

- ① Press the [FUNC] switch to light its indicator, and then press the [SETUP] switch to display the SETUP menu.
- ② Turn [F1] to display the OUPHS menu.
- ③ Turn [F2], and select 0H or 1H using the SYS item.
0H: The output video signals are output to the system REF signal with using in-phase.
The frame synchronizer function is ON for all input signals.
1H: The output video signals are output to the system REF signal with 1H delay.
- ④ Turn [F3] to adjust HPHASE using the H item, and turn [F4] to adjust VPHASE using the V item.
HPHASE can be adjusted within a range of $-0.5H$ to $+0.5H$ and VPHASE within a range of $-100H$ to $+100H$.

O U P H S	S Y S	H	H
6 / 1 4	1 H	- 1 0 0 0	- 1 0 0

0 H

Output video signal phase adjustment (The numbers given are provisional.)

Phase	Video format	Adjustment range
HPHASE	1080i/59i	-1094 to 1094
	1080/50i	-1314 to 1314
	720/59p	-819 to 819
	720/50p	-984 to 984
	480/59i	-852 to 852
	576/50i	-858 to 858
VPHASE	Same for all formats	-100 to 100

3. Setup

<Phase adjustment setup>

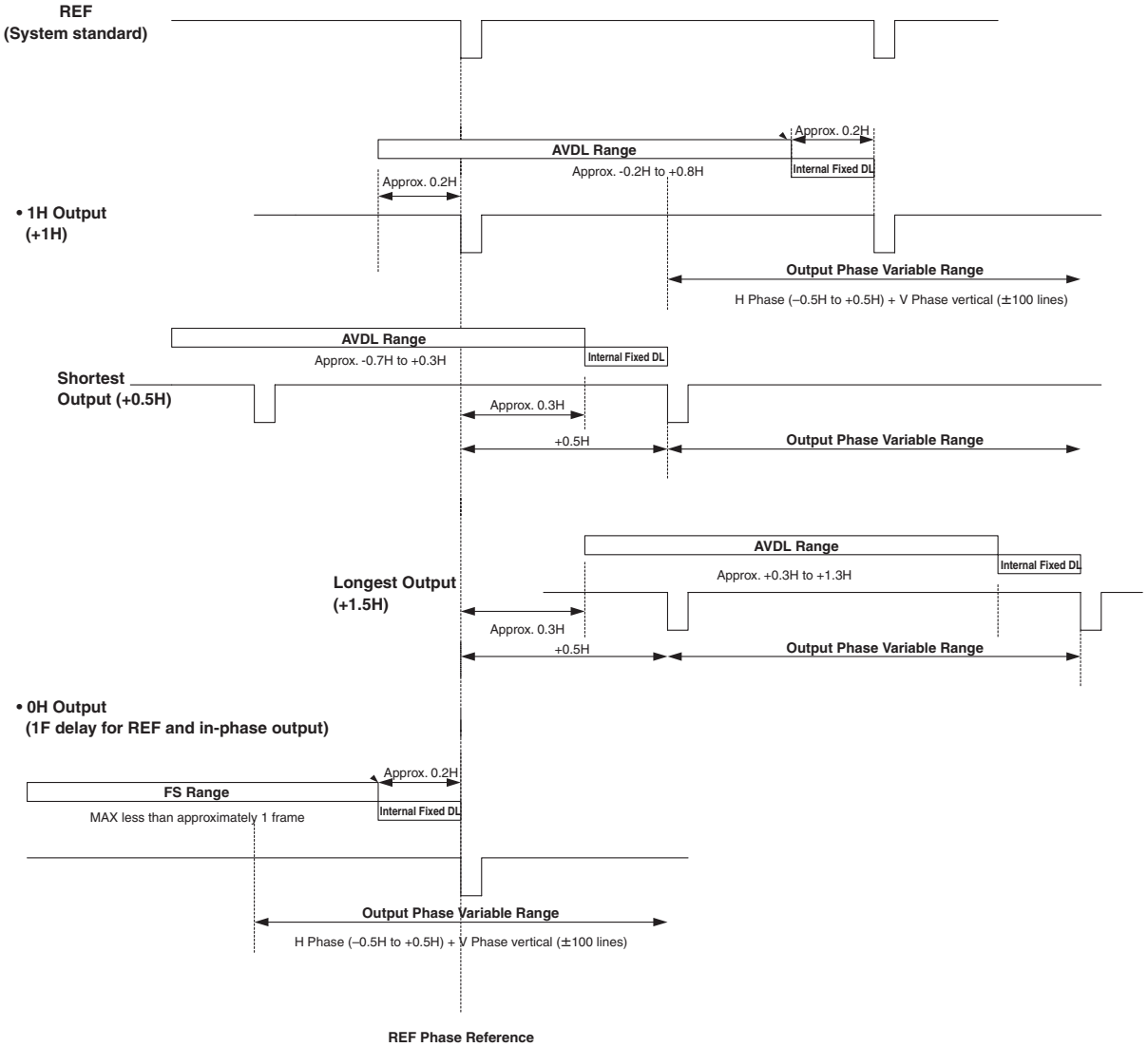

AVDL Range: Range for automatic phase adjustment.

3. Setup

3-7. Network settings

Set up the network for transmitting image files by Ethernet. For details on image transmission method, refer to "5. Image transmission functions".

The network setup is: IP address: 192.168.0.10, subnet mask: 255.255.255.0 and gateway: 0.0.0.0 (unused). When using the host computer with settings matching the network setup, it is not necessary to setup via the menu.

For the setting to take effect, the system must be rebooted. Turn the system's power off and then back on.

■Setting the IP address

- ① Press the [FUNC] switch to light its indicator, and then press the [SETUP] switch to display the SETUP menu.
- ② Turn [F1] to display the IP menu.
- ③ Turn [F2] to select the setting location. An asterisk (*) appears at the setting location.
- ④ Turn [F3] to set the number, and press the [F3] switch to enter the setting. If the setting is not entered even though it has been changed, "!" appears above the setting location, and when the setting location is moved by turning [F2], the value prior to the change is restored.

IP		!	*
7 / 1 4		1 9 2 .	1 6 8 . 0 . 1 0

■Setting the subnet mask

- ① On the SETUP menu, turn [F1] to display the MASK menu.
- ② Turn [F2] to select the setting location. An asterisk (*) appears at the setting location.
- ③ Turn [F3] to set the number, and press the [F3] switch to enter the setting. If the setting is not entered even though it has been changed, "!" appears above the setting location, and when the setting location is moved by turning [F2], the value prior to the change is restored.

MASK		*
8 / 1 4		2 5 5 . 2 5 5 . 2 5 5 . 0

3. Setup

■Setting the gateway

- ① On the SETUP menu, turn [F1] to display the GW (Gateway) menu.
- ② Turn [F2] to select the setting location. An asterisk (*) appears at the setting location.
- ③ Turn [F3] to set the number, and press the [F3] switch to enter the setting. If the setting is not entered even though it has been changed, “ ! ” appears above the setting location, and when the setting location is moved by turning [F2], the value prior to the change is restored.

GW		*				
9 / 1 4		0 .	0 .	0 .	0	

■Setting the MAC address

- ① On the SETUP menu, turn [F1] to display the MAC menu.
The MAC address now appears.

MAC															
1 0 / 1 4		0	0	8	0	4	5	1	2	3	4	5	6		

3. Setup

3-8. Other settings

3-8-1. LCD backlight

The LCD backlight can be set to ON or OFF.

- ① Press the [FUNC] switch to light its indicator, and then press the [SETUP] switch to display the SETUP menu.
- ② Turn [F1] to display the SYS menu.
Turn [F2], and select ON or OFF for the backlight using the BL item.

SYS	BL	VANC	BB
1 2 / 1 4	ON	OFF	7. 5
	OFF	ON	0

3-8-2. Setting the ancillary data

Whether the ancillary data which is superimposed on the vertical blanking period of the input images is to be passed through can be selected. The data will not pass through during a transition.

- ① Press the [FUNC] switch to light its indicator, and then press the [SETUP] switch to display the SETUP menu.
- ② Turn [F1] to display the SYS menu.
Turn [F3], and select ON or OFF for the ancillary data using the VANS item.
ON: The ancillary data is passed through.
OFF: The ancillary data is not passed through.

SYS	BL	VANC	BB
1 2 / 1 4	ON	OFF	7. 5
	OFF	ON	0

3-8-3. BB signal setup level

The setup level of the BB signal in the internal sync mode can be selected. The level selected takes effect with the 59.94i or 59.94p format. It is fixed at 0 IRE with the 50i or 50p format.

- ① Press the [FUNC] switch to light its indicator, and then press the [SETUP] switch to display the SETUP menu.
- ② Turn [F1] to display the SYS menu.
Turn [F2], and select the setup level using the BB item.
0: 0 IRE
7.5: 7.5 IRE

SYS	BL	VANC	BB
1 2 / 1 4	ON	OFF	7. 5
	OFF	ON	0

3. Setup

3-9. Status displays

The statuses can be displayed.

- ① Press the [FUNC] switch to light its indicator, and then press the [SETUP] switch to display the SETUP menu.
- ② Turn [F1] to display the STATS menu.

ALM (alarm): Indicates a fan and/or power supply alarm.

FAN → Fan alarm

POWR → Power supply alarm

F, P → Fan alarm and power supply alarm

NO → No alarm information

OPT (option): Indicates whether or not an optional board is provided.

ANLG → The HD analog component option has been inserted.

NO → The HD analog component option has not been inserted.

VER (version): Indicates the software version.

STATS	ALM	OPT	VER
14 / 14	FAN	ANLG	1.00

POWR
F, P
NO

NO

3-10. Initialization

All the settings can be returned to the factory defaults.

(When they are returned, the images in the frame memory will also be initialized.)

- ① Press the [FUNC] switch to light its indicator, and then press the [SETUP] switch to display the SETUP menu.
- ② Turn [F1] to display the INIT menu.
- ③ Press [F2] to initialize the settings. The "INIT?" message appears.
- ④ To initialize the settings, turn [F2] to select YES, and then press the [F2] switch.
To cancel the initialization, turn [F2] to select NO, and then press the [F2] switch.

INIT	INIT	
13 / 14	EXEC	



INIT	INIT?	
13 / 14	NO	

YES

4. Setting menu table

A setting is entered when an item is selected and then the [F1], [F2], [F3] or [F4] switch is pressed.
(It will not be entered unless the switch is pressed.)

Menu	Submenu		Parameter 1	Parameter 2	Parameter 3
	Turn F1 to select.		Turn F2 to select.	Turn F3 to select.	Turn F4 to select.
TIME	BKGD	Parameter	TIME		UNIT
	1/2	Setting range	0 to 13s	0 to 999f	F SEC
		Default value	—	60f	SEC
	KEY	Parameter	TIME		UNIT
	2/2	Setting range	0 to 13s	0 to 999f	F SEC
		Default value	—	60	SEC
WIPE	BODR	Parameter	WIDT	SOFT	COLR
	1/5	Setting range	0 to 255	0 to 255	WHT, YLW, CYN GRN, MGT, RED BLE, BLK USR1 to 4
		Default value	50	0	YLW
	USR1(*)	Parameter	HUE	SAT	LUM
	2/5	Setting range	0 to 359	0 to 100	0 to 108
		Default value	0	0	100
	USR2(*)	Parameter	HUE	SAT	LUM
	3/5	Setting range	0 to 359	0 to 100	0 to 108
		Default value	355	100	7
	USR3(*)	Parameter	HUE	SAT	LUM
	4/5	Setting range	0 to 359	0 to 100	0 to 108
		Default value	50	100	29
USR4(*)	Parameter	HUE	SAT	LUM	
5/5	Setting range	0 to 359	0 to 100	0 to 108	
	Default value	0	0	0	
CBGD	CBGD	Parameter	COLR	—	—
	1/5	Setting range	WHT, YLW, CYN GRN, MGT, RED BLE, BLK USR1 to 4	—	—
		Default value	WHT		
	USR1(*)	Parameter	HUE	SAT	LUM
	2/5	Setting range	0 to 359	0 to 100	0 to 108
		Default value	0	0	100
	USR2(*)	Parameter	HUE	SAT	LUM
	3/5	Setting range	0 to 359	0 to 100	0 to 108
		Default value	355	100	7
	USR3(*)	Parameter	HUE	SAT	LUM
	4/5	Setting range	0 to 359	0 to 100	0 to 108
		Default value	50	100	29

4. Setting menu table

Menu	Submenu		Parameter 1	Parameter 2	Parameter 3
	Turn F1 to select.		Turn F2 to select.	Turn F3 to select.	Turn F4 to select.
CBGD	USR4(*)	Parameter	HUE	SAT	LUM
	5/5	Setting range	0 to 359	0 to 100	0 to 108
		Default value	0	0	0
KEY	KEY	Parameter	TYPE	INV	PVW
	1/7	Setting range	SELF LIN	ON OFF	ON OFF AUTO
		Default value	LIN	OFF	AUTO
	KADJ	Parameter	CLIP	GAIN	DENS
	2/7	Setting range	0 to 255	0 to 200	0 to 100
		Default value	100	100	100
	FILL	Parameter	TYPE	COLR	
	3/7 ◇KEY-F Link from switch	Setting range	BUS COLR	WHT, YLW, CYN GRN, MGT, RED BLE, BLK USR1 to 4	
		Default value	BUS	BLE	
	USR1(*)	Parameter	HUE	SAT	LUM
	4/7	Setting range	0 to 359	0 to 100	0 to 108
		Default value	0	0	100
	USR2(*)	Parameter	HUE	SAT	LUM
	5/7	Setting range	0 to 359	0 to 100	0 to 108
		Default value	355	100	7
	USR3(*)	Parameter	HUE	SAT	LUM
	6/7	Setting range	0 to 359	0 to 100	0 to 108
Default value		50	100	29	
USR4(*)	Parameter	HUE	SAT	LUM	
7/7	Setting range	0 to 359	0 to 100	0 to 108	
	Default value	0	0	0	
EDGE	EDGE	Parameter	TYPE	WIDT	COLR
	1/5	Setting range	OFF BORD DROP SHDW OUTL	0 to 8	WHT, YLW, CYN GRN, MGT, RED BLE, BLK USR1 to 4
		Default value	DROP	4	YLW
	USR1(*)	Parameter	HUE	SAT	LUM
	2/5	Setting range	0 to 359	0 to 100	0 to 108
		Default value	0	0	100
USR2(*)	Parameter	HUE	SAT	LUM	
3/5	Setting range	0 to 359	0 to 100	0 to 108	
	Default value	355	100	7	

4. Setting menu table

Menu	Submenu		Parameter 1	Parameter 2	Parameter 3
	Turn F1 to select.		Turn F2 to select.	Turn F3 to select.	Turn F4 to select.
EDGE	USR3(*)	Parameter	HUE	SAT	LUM
	4/5	Setting range	0 to 359	0 to 100	0 to 108
		Default value	50	100	29
	USR4(*)	Parameter	HUE	SAT	LUM
	5/5	Setting range	0 to 359	0 to 100	0 to 108
		Default value	0	0	0
MEM	PSMEM	Parameter	MODE	NO.	
	1/3	Setting range	STOR RECL CLR	*1 to 10	EXEC (↓)
		Default value	STOR	1	—
	PSMEM	Parameter	XPT	—	—
	2/3	Setting range	DSBL ENBL	—	—
		Default value	DSBL	—	—
	FMEM	Parameter	SIG	MEM	STOR
	3/3	Setting range	AUX	FMEM	EXEC (↓)
	Default value	—	—	—	
XPT	XPTAS	Display only	SIG: B 1 2 3 4 5 D XPT: 1 2 3 4 5 6 7		
	1/3				
	XPTAS	Parameter	XPT	SIG	—
	2/3	Setting range	1 to 7	IN1 to 5, DVI BLK, CBGD, CBAR, FMEM	—
		Default value	1	BLK	—
			2	IN1	—
			3	IN2	—
			4	IN3	—
			5	IN4	—
			6	IN5	—
		7	DVI	—	
XPTSW	Parameter	TIMG	—	—	
3/3	Setting range	ANY F1 F2	—	—	
	Default value	ANY	—	—	
FRZ	FRZ	Display only	FRZ: * * * * * XPT: 1 2 3 4 5 6 7		
	1/2				
	FRZ	Parameter	SIG	—	FRZ
	2/2	Setting range	IN1 to 5, DVI	—	Toggleing between ON and OFF (↓)
	Default value	IN1 to 5, DVI	—	ON (Freeze OFF status)	

4. Setting menu table

Menu	Submenu		Parameter 1	Parameter 2	Parameter 3
	Turn F1 to select.		Turn F2 to select.	Turn F3 to select.	Turn F4 to select.
SETUP	IN1-5	Parameter	SIG	MODE	—
	1/14	Setting range	IN1 to 5	SDI ANLG	—
		Default value	IN1 to 5	SDI	—
	DVIIN	Parameter	SIZE	SCAL	MODE
	2/14	Setting range	SXGA XGA	NORM FULL	DIG ANLG
		Default value	SXGA	NORM	DIG
	FS	Parameter	SIG	FS	—
	3/14	Setting range	IN1 to 5	ON OFF	—
		Default value	IN1 to 5	ON	—
	FORMT	Parameter	MODE	—	—
	4/14	Setting range	*1080/59i 1080/50i 720/59p 720/50p 480/59i 576/50i	—	EXEC (↓)
		Default value	1080/59i	—	—
	REF	Parameter	SYNC	—	—
	5/14	Setting range	*BBST BBAD TRI INT	—	EXEC (↓)
		Default value	BBST	—	—
	OUPHS	Parameter	SYS	H	V
	6/14	Setting range	0H 1H	-1369 to 1369?	-100 to 100?
		Default value	0H	0	0
	IP	Setting range	Cursor movement	0 to 255	
	7/14	Default value	192.168.0.1		
	MASK	Setting range	Cursor movement	0 to 255	
	8/14	Default value	255.255.255.0		
	GW	Setting range	Cursor movement	0 to 255	
9/14	Default value	0.0.0.0			
MAC	Display only	12-digit address display			
10/14	Default value	—			
BUS	Parameter	TYPE	—	—	
11/14	Setting range	A/B P/P (PGM/PST)	—	—	
	Default value	P/P	—	—	

4. Setting menu table

Menu	Submenu		Parameter 1	Parameter 2	Parameter 3
	Turn F1 to select.		Turn F2 to select.	Turn F3 to select.	Turn F4 to select.
SETUP	SYS	Parameter	BL	VANC	BB
	12/14	Setting range	ON OFF	ON OFF	0 7.5
		Default value	ON	OFF	7.5
	INIT	Parameter	INIT	—	—
	13/14	Setting range	EXEC (↓)		
	STATS	Parameter	ALM	OPT	VER
	14/14	Display only	FAN POWER F, P NO	ANLG NO	Version number

5. Image transmission functions

This unit comes with a function for transmitting still images from the host computer to the unit via Ethernet and a function for importing still images from the unit into the host computer. The image transmission program must be installed in the host computer from the CD-ROM supplied in order to use these functions. For details on installation, refer to “How to install the program”.

■Specifications

Run the image transmission program (HS300 Tool) in a host computer which satisfies the following conditions.

- Operating system: Windows2000 or WindowsXP
- Processor: Pentium III, 1 GHz or better recommended
- RAM: 256 MB or more recommended
- Hard disk drive: At least 50 MB of free memory
- Ethernet: 10BASE-T or 100BASE-TX
- Display: TrueColor (24 bit, 32 bit color), 800×600 dots or more

The image formats supported include bitmap (bmp), JPEG (jpg or jpeg), TIFF (tif) and GIF (gif).

The image transmission program is equipped with a function for automatically converting images into the specified video format size.

■Connections

Connect this unit to Ethernet using a twisted pair cable. Use a LAN crossover cable to connect the unit with the host computer directly. Use a LAN straight cable to connect to Ethernet using a hub or other equipment.

For details on network setup such as IP addresses, refer to [3-7 Network settings].

Transmitting images uses network capacity which may result in other connected devices possibly being affected when connecting to Ethernet through a hub and other equipment.

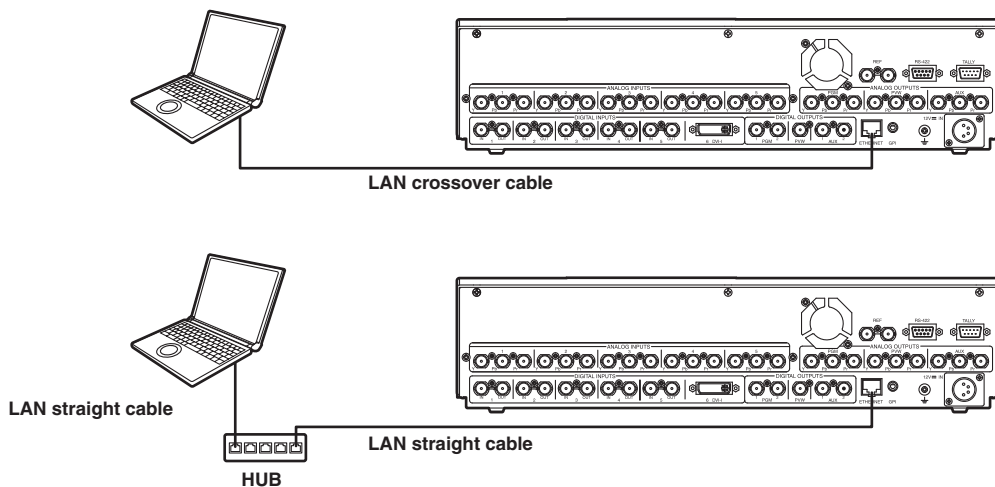

5. Image transmission functions

■How to install the program

This section describes how to install the image transmission program (HS300 Tool). Windows XP is used as the host computer's operating system in the example given here.

1. Insert the CD-ROM supplied with the unit into the CD-ROM drive of the host computer in which the program will be installed. (Here, E: will serve as the name of this drive for example.)
2. Execute the setup program (E:\HS300TOOL\JPN\SETUP.EXE).
3. The installer now starts up so follow its instructions to proceed.



4. The Setup Complete screen appears to indicate that installation is complete. Click [Finish] to close the window.



5. Image transmission functions

■Operation

This section describes how to operate the image transmission program (HS300 Tool).

<Startup>

On the Start menu of Windows, select [Programs] → [Panasonic] → [HS300Tool].
The main screen now appears.



<Exit>

Click the [CLOSE] button.

<Setting the IP address>

Set the unit's IP address in the IP Address setting box.

5. Image transmission functions

<Transmitting images to the unit>

1. Select the mode.
Check that "To HS300" appears in the [Mode] field.
If "From HS300" appears instead, click the Mode button so that "To HS300" appears.
2. When the [Select Image] button is clicked, the file selection dialog box appears on the screen.
Select the image file to be transmitted, and click [OK].
The image is now displayed in the image display area, and its horizontal and vertical dimensions appear in the [Width] and [Height] fields at the bottom right.
3. In the [Size] field, select the size of the image to be transmitted to the unit.
HD1080 (1920×1080), HD720 (1280×720), SD NTSC (720×480) or SD PAL (720×576) can be selected as the size. If the image is in a different video format from the ones supported by the unit, one part of the image output of the unit will be displayed or the image will be displayed only on part of the screen.
4. In the [Aspect] field, select the scaling method.
If the size of the image to be transmitted and the selected image differ, the image will be automatically scaled according to one of the following methods.
Full: The size of the image is increased or reduced so that it fits the size selected in the [Size] field. If the aspect ratio of the image to be transmitted differs from that of the selected image, the ratio between the horizontal and vertical dimensions will be changed.
Keep: The image is expanded or reduced while its original aspect ratio is kept unchanged.
Any empty spaces in the image will appear black.
5. Click the [Select Image] button to transmit the image to the unit.

<Transmitting images from the unit>

1. Select the mode.
Check that "From HS300" appears in the [Mode] field.
If "To HS300" appears instead, click the Mode button so that "From HS300" appears.

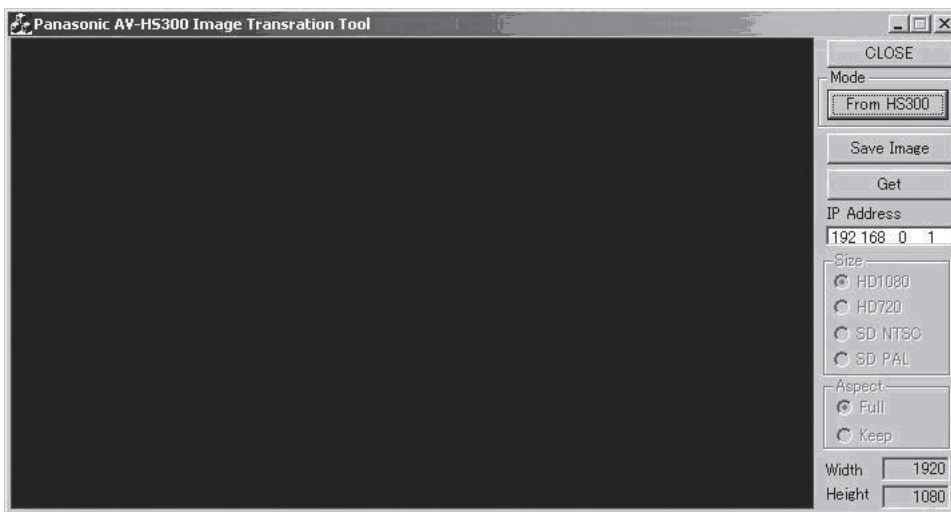

2. When the [Get] button is clicked, the image is imported from the unit.
The image is now displayed in the image display area, and its horizontal and vertical dimensions appear in the Width and Height fields at the bottom right.
3. When the [Save Image] button is clicked, the file save dialog box appears on the screen. Select the image file to be transmitted, and click [Save].

6. External interfaces

This unit comes with RS-422, GPI and tally connectors to serve as external interfaces.

6-1. RS-422 connector

This enables the unit to be controlled by an external device. Use it with the settings below.

Baud rate: 38400 bps

Parity: ODD

Stop bit: 1 bit

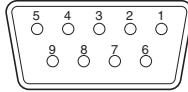

Pin assignment

Pin No.	Signal name	Description of signal
1	FRAME GROUND	Frame ground
2	RXD –	Receive data (–)
3	TXD +	Send data (+)
4	GROUND	Ground
5	NC	Not used
6	GROUND	Ground
7	RXD +	Receive data (+)
8	TXD –	Send data (–)
9	FRAME GROUND	Frame ground

6-2. GPI connector

This enables auto take operations to be executed by an external device. Auto transitions are executed at the fall of the GPI signals.

6-3. Tally connector

The tally connector comes with tally output, output enable, power supply or fan alarm output pins. The output signals from the tally output pins are for lighting the tally lamps, and these outputs are open collector outputs.

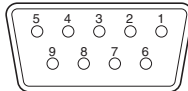

Pin assignment

Pin No.	Signal name	Input/output	Description of signal
1	IN1	Open collector output	Tally output of input video 1
2	IN2	Open collector output	Tally output of input video 2
3	IN3	Open collector output	Tally output of input video 3
4	IN4	Open collector output	Tally output of input video 4
5	IN5	Open collector output	Tally output of input video 5
6	IN6	Open collector output	Tally output of input video 6
7	ENABLE	Input	Enable signal of tally output Open: Output; GND: no output
8	ALARM	Open collector output	Fan alarm or power supply alarm output
9	GROUND	GROUND	Ground

7. Connections

■Connections when implementing gen-lock (frame synchronizer OFF)

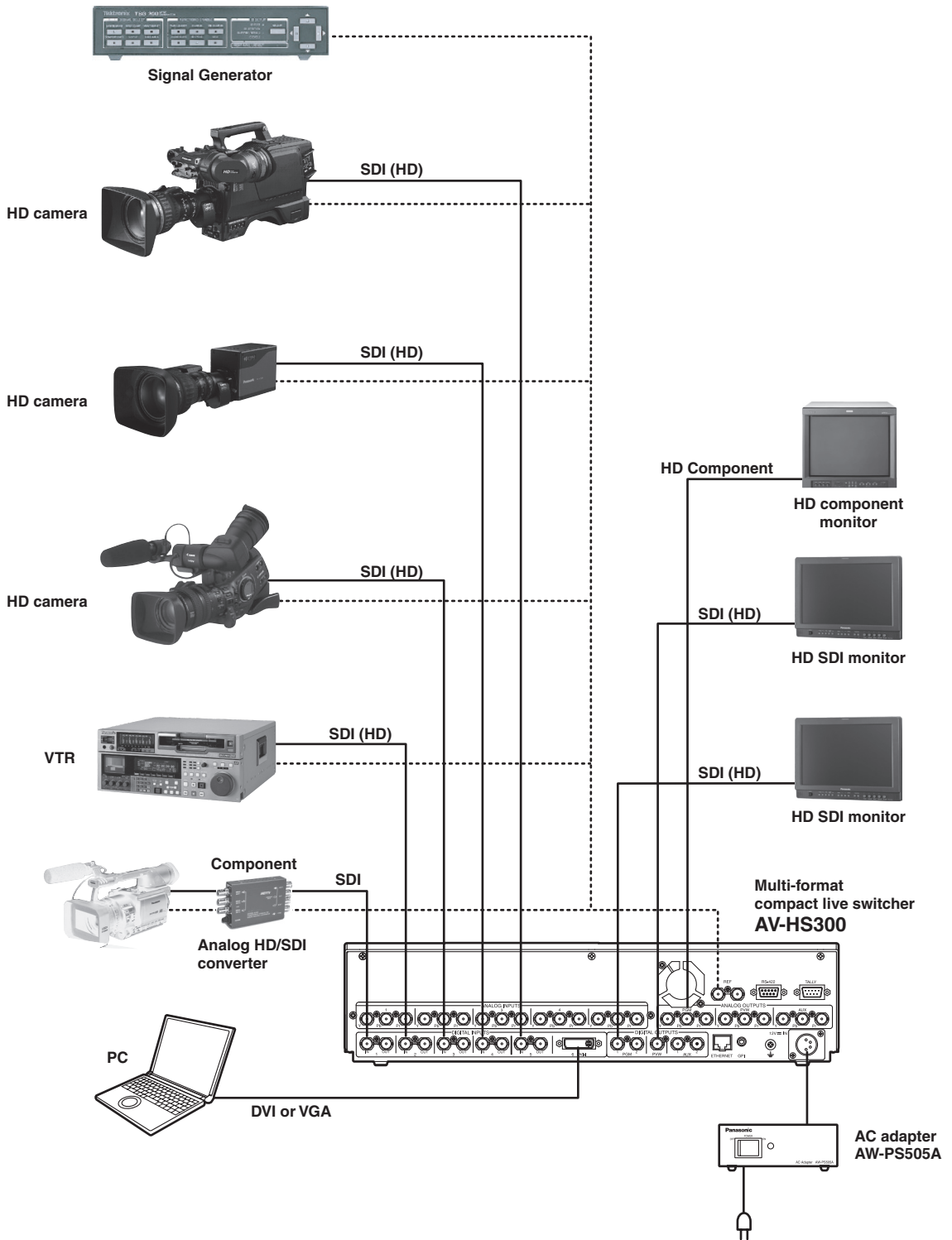

7. Connections

■ Connections when not implementing gen-lock (frame synchronizer ON)

- Example where the HD analog input option is used

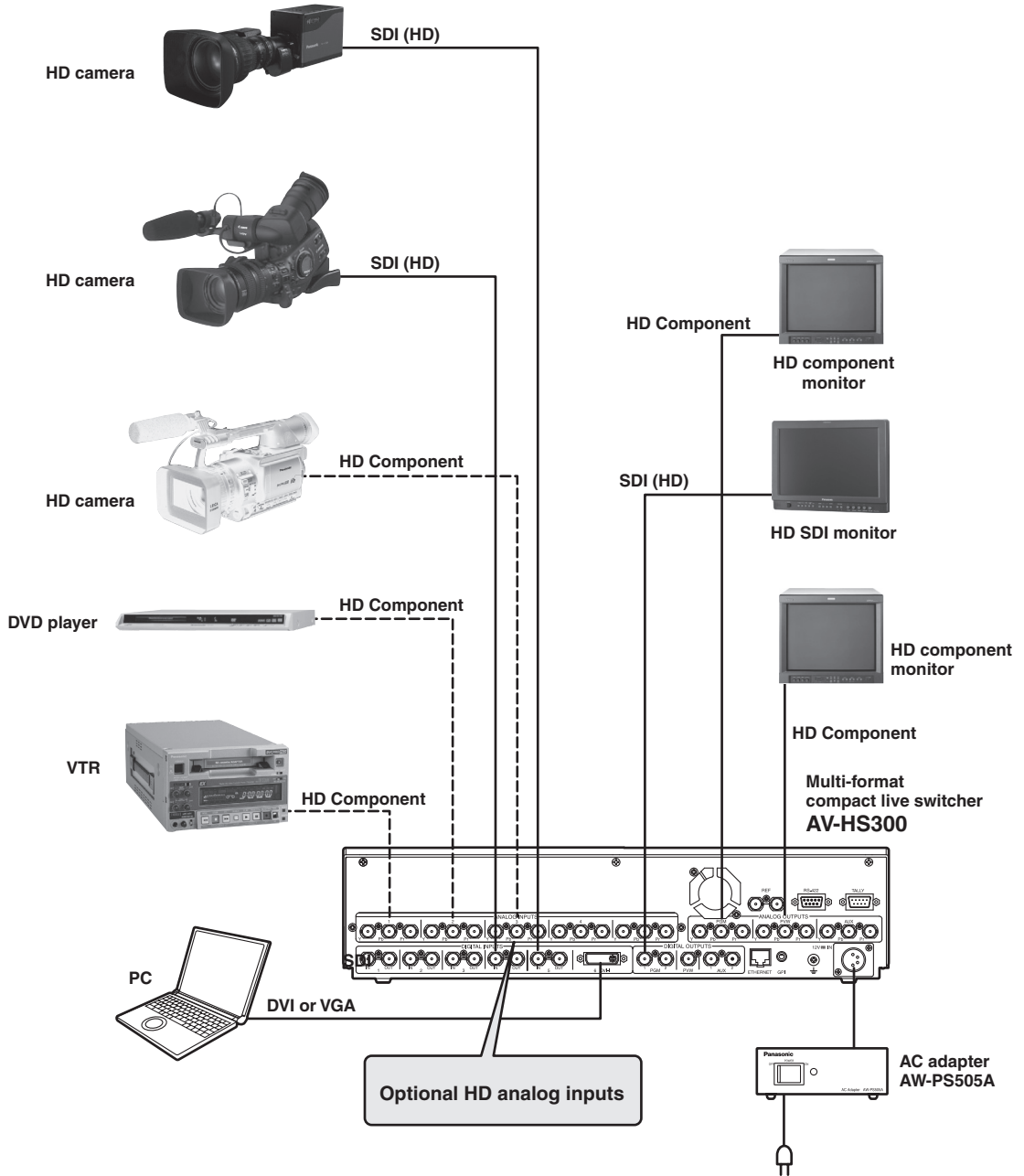

8. Appearance

Unit: mm

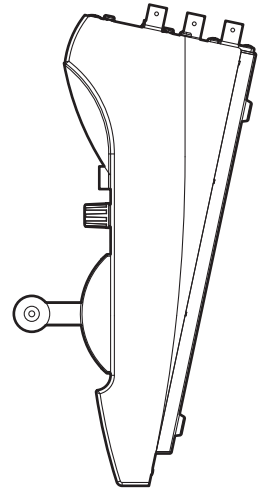
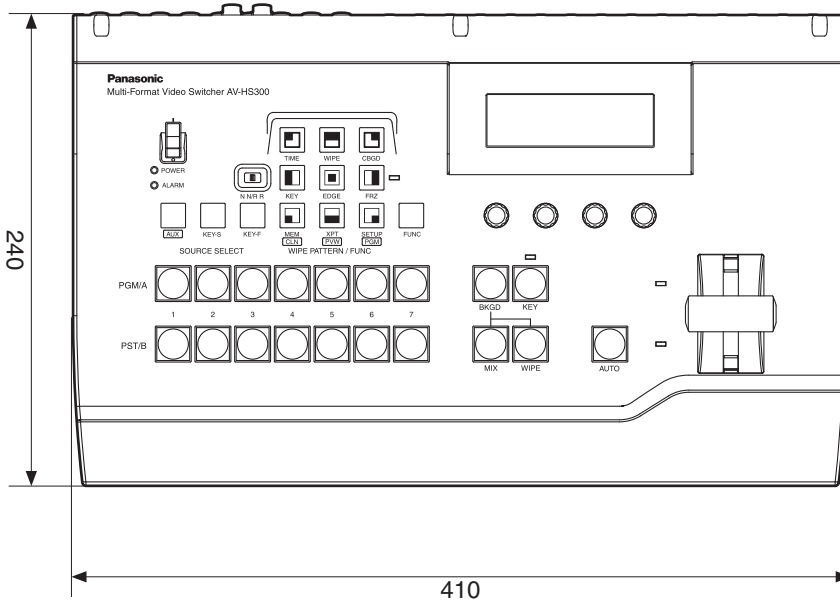
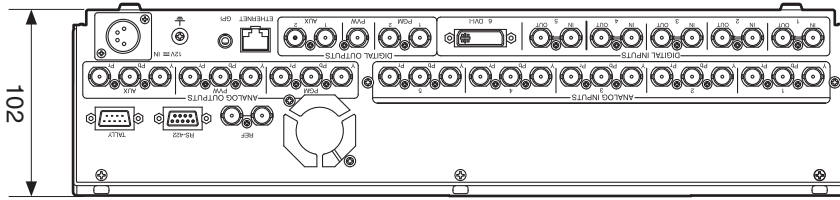

Specifications and standard accessories

■ Specifications

Inputs	Video inputs×6 (SDI×5, DVI-I×1, analog HD×5 (optional)) Reference×1
Outputs	Video outputs×3 (PGM, PVW, AUX) PGM: SDI×2 outputs, analog HD×1 output PVW: SDI×1 output, analog HD×1 output AUX: SDI×2 outputs, analog HD×1 output Reference×1
Signal formats	SD: 480/59.94i, 576/50i HD: 1080/59.94i, 1080/50i, 720/59.94p, 720/50p
Signal processing	Y:Cb:Cr 4: 2: 2, 10 bit RGB 4:4:4, 8 bit
ME number	1ME
SDI inputs	HD: Serial digital (SMPTE 292M) SD: Component digital (SMPTE 259M)
	IN1 to 5 (with active through)
	HD (SMPTE 292M (BTA S-004B) standard complied with) • 0.8 Vp-p ±10 % (75 Ω) • Input return loss More than 15 dB (5 MHz to 750 MHz) More than 10 dB (750 MHz to 1.5 GHz) • Automatic equalizer More than 100 m (5C-FB)
	SD (SMPTE 259M standard complied with) • 0.8 Vp-p ±10 % (75 Ω) • Input return loss More than 15 dB (5 MHz to 270 MHz) • Automatic equalizer 200 m (5C-2V)
SDI outputs	HD: Serial digital (SMPTE 292M) SD: Component digital (SMPTE 259M)
	PGM, PVW, AUX
	HD (SMPTE 292M (BTA S-004B) standard complied with) • Output return loss More than 15 dB (5 MHz to 750 MHz) More than 10 dB (750 MHz to 1.5 GHz)) • Output level 0.8 Vp-p ±10 % • Rise time Less than 270 ps • Fall time Less than 270 ps • Difference between rise time and fall time Within 100 ps • Alignment jitter Less than 0.2 UI (130 ps) • Timing jitter Less than 1.0 UI • Eye aperture ratio More than 90 % • DC offset 0 ±0.5 V

Specifications and standard accessories

SDI outputs	SD (SMPTE 259M standard complied with)	
	• Output return loss	More than 15 dB (5 MHz to 270 MHz)
Analog HD input (*option)	• Output level	0.8 Vp-p \pm 10 %
	• Rise time	Less than 1.5 ns
	• Fall time	Less than 1.5 ns
	• Difference between rise time and fall time	Less than 0.5 ns
	• Jitter	Less than 0.2 UI
	• Jitter	Less than 0.2 UI
Analog HD output	HD analog component Y/Pb/Pr (1.0 Vp-p, 75 Ω)	
	PGM, PVW, AUX	
DVI-I input	SXGA 1280 \times 1024, XGA 1024 \times 768 (60 Hz)	
Key input	1 input from video inputs	
Reference input	Black burst or TRI signal (with loop-through) \times 1	
Reference output	In gen-lock mode: loop-through output \times 1, In internal sync mode: black burst \times 2	
Video delay time	Frame synchronizer OFF	1H
	Frame synchronizer ON	1F
Control I/O	Ethernet	100 Mbps/10 Mbps \times 1 Image transmission function available (provided with transmission program)
	Serial communication interface	RS-422A (D-SUB 9-pin) \times 1
	Tally output	Open collector outputs (negative logic) 1 to 6
	GPI	Auto take \times 1
Ambient operating temperature	0 $^{\circ}$ C to 40 $^{\circ}$ C	
Humidity	10 to 90 % (no condensation)	
Power supply	DC 12 V \pm 2 V	
	Power consumption	Pending
Dimensions	410 (W) \times 102 (H) \times 240 (D) mm (Excluding protrusions)	
Weight	6.8 kg	

■ Standard accessories

Operating instructions	1
Operation manual/Image transmission program install CD	1

■ Optional accessories

Analogue HD input option board AV-HSB300

Appendix (glossary)

Defined below are the terms used in this manual.

Word	Explanation
AB Bus AB Bus system	A bus control mode. By executing a transition, the A bus and B bus signals are output to the program images alternately.
Ancillary Data	The auxiliary data other than the video signals which is transmitted inside the data stream of the video serial interface. The data superimposed on the vertical blanking period is referred to as the V ancillary data (VANC).
Aspect ratio	The ratio between the horizontal and vertical dimensions of an image or screen. It is 16:9 for the HD format and 4:3 for the SD format.
AUX [Auxiliary Bus]	A spare bus which can be switched by signals other than the main line output signals.
AVDL [Automatic Video Delayline] Automatic phase adjustment	A function to automatically adjust the input image signal phase to the horizontal synchronization reference signal phase.
BB Black burst	The black burst signal. A full-screen black level composite signal which is used as the reference signal for gen-lock.
Border	The area or margin that is added to the edge of a wipe or key. Its width and color can be adjusted. The defocusing of the area around a border is referred to as the soft effect.
Clip	The threshold level of the luminance when key signals are created from a key source.
Color Background	The signals which are output from the internal color generator and used as the background image.
Density	A parameter which is used to adjust the density of the key signals.
DVI [Digital Visual Interface]	A digital video interface standard. DVI-I can handle both digital signals and analog signals.
Ethernet	A computer network standard; the 10BASE-T (10 Mbps), 100BASE-TX (100 Mbps) or other such standard based on the transmission speed.
Flip Flop system	A bus control mode. The signals selected by the program bus are always output as the program images. By executing a transition, the program bus and preset bus signals are switched over.
Frame Memory	A memory which can hold the video signals equivalent to one frame.
Frame Synchronizer	A function which enables the non-synchronized video signal input to be switched.
Freeze	A function which continues the display of the same image, creating the impression that the image has been "frozen".
Gain	A parameter which adjusts the defocusing of the edges of the key signals.

Appendix (glossary)

Word	Explanation
Genlock	A function for synchronizing the video signals using an external sync signal as the reference.
GPI [General Purpose Interface]	Interface signals which control auto transition from an external source.
IRE	A unit used for video signal levels. The setup level (black level) of the signals is expressed as 0 IRE, 7.5 IRE, etc.
Hue	The color tone of the video signals.
Key Edge	The border or shadow added to the edges of keys.
Key Fill	The signal that uses key combination processing to fill in the areas left blank by the key signals.
Key Inversion	A function which inverts the key signals.
Key Source	The video signals for creating the key signals.
Linear Key	The function which combines keys using monochrome key signals with gradations in its outlines as a reference.
Lum [Luminance]	The brightness portion of the video signals.
Luminance Key	The function which creates key signals based on the luminance (brightness) information of the video signals to combine keys.
ME [Mix Effect]	A video effect device which combines a number of video signals to create mix, wipe, key and other video signals.
Mix	The picture-changing effect produced by overlapping one image with the next. It is also referred to as "dissolve".
Preview	The function for checking ahead of time the image which will be output after the next transition. The image is output from the PVW system.
Program Bus	The bus which always carries the program output signals.
Preset Bus	The bus which carries the program output signals after the next background transition.
Preset Memory	The memory in which the control panel statuses can be saved and recalled. The switch selection statuses as well as the border, color and other setting information can be saved in this memory.
RS-422	A serial interface standard. It is the interface used to control the switcher from an editor or other external device.
Sat [Saturation]	This refers to the intensity of the color of video signals.

Appendix (glossary)

Word	Explanation
SDI [Serial Digital Interface]	The standard by which video signals in various SD and HD formats are transmitted along a single coaxial cable.
Self Key	A function that creates key signals from key fill signals for combining keys.
Tally	The signal which outputs the program output statuses of the input signals to an external device. The LED that indicates the program output status on the control panel is also referred to as tally.
Transition	A function that switches from one image to another. Wipe, mix and other effects are available for the images during switching.
Tri Sync	The sync signal used for HD formats. It is also referred to as tri-level sync.
Wipe	A video effect in which one image is gradually replaced by another as the boundary between the two is moved using a preselected pattern.

Panasonic[®]

PANASONIC BROADCAST & TELEVISION SYSTEMS COMPANY
UNIT COMPANY OF PANASONIC CORPORATION OF NORTH AMERICA

Executive Office:

One Panasonic Way 4E-7, Secaucus, NJ 07094 (201) 348-7000

EASTERN ZONE:

One Panasonic Way 4E-7, Secaucus, NJ 07094 (201) 348-7621

Southeast Region:

1225 Northbrook Parkway, Ste 1-160, Suwanee, GA 30024 (770) 338-6835

Central Region:

1707 N Randall Road E1-C-1, Elgin, IL 60123 (847) 468-5200

WESTERN ZONE:

3330 Cahuenga Blvd W., Los Angeles, CA 90068 (323) 436-3500

Government Marketing Department:

52 West Gude Drive, Rockville, MD 20850 (301) 738-3840

Broadcast PARTS INFORMATION & ORDERING:

9:00 a.m. – 5:00 p.m. (PST) (800) 334-4881/24 Hr. Fax (800) 334-4880

Emergency after hour parts orders (800) 334-4881

TECHNICAL SUPPORT:

Emergency 24 Hour Service (800) 222-0741

Panasonic Canada Inc.

5770 Ambler Drive, Mississauga, Ontario L4W 2T3 (905) 624-5010

Panasonic de Mexico S.A. de C.V.

Av angel Urraza Num. 1209 Col. de Valle 03100 Mexico, D.F. (52) 1 951 2127

Panasonic Puerto Rico Inc.

San Gabriel Industrial Park, 65th Infantry Ave., Km. 9.5, Carolina, Puerto Rico 00630 (787) 750-4300

© 2006 Matsushita Electric Industrial Co., Ltd. All rights reserved.